



# Phoenix 4800E - Desiccant Dehumidifier

## OWNER'S MANUAL

### Installation, Operation & Service Instructions - READ AND SAVE THESE INSTRUCTIONS -

Congratulations on your purchase of the Phoenix 4800E dehumidifier. This dehumidifier offers the finest in air-drying equipment. However, this machine can only provide maximum service and performance if properly installed, operated and maintained.

This owner's manual is provided to acquaint you with the dehumidifier so that the installation, operation and maintenance can proceed successfully. Ultimate satisfaction depends on the quality of the installation and thorough understanding of the operation of this equipment. The dehumidifier is built around tested engineering principles and has passed a thorough inspection for quality of workmanship and function.



Phoenix 4800E  
(with Frame)  
PN 4034830

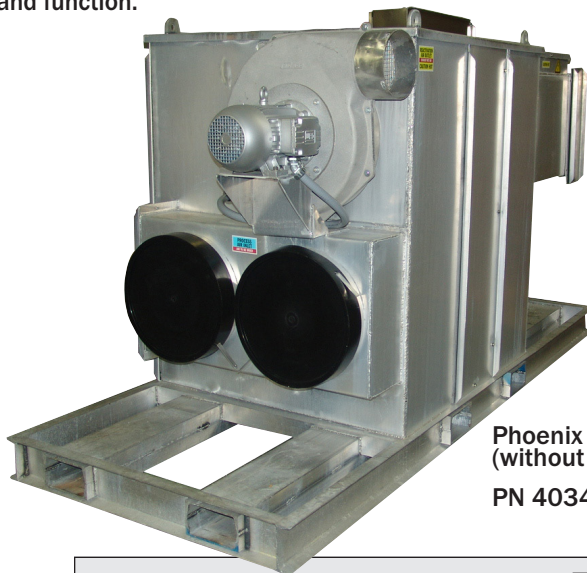

Phoenix 4800E  
(without Frame)  
PN 4034820



Intertek

### The Phoenix 4800E

- 3032 pints/day AHAM
- 4800 CFM process airflow
- Dries in temperatures to 140°F
- Reaches dew points as low as -40°F
- 48"W x 120"L x 74"H
- 1600 lbs. (Standard machine weight only)
- 480 volt 3-phase
- 106 full load amps



TS-451

Specifications subject to change without notice. 08/19 Rev. C



## Table of Contents

Introduction .....	1
1. Specifications .....	2
2. Operation.....	2
2.1 How the Phoenix 4800E Works .....	3
3. Installation .....	3
3.1 Inspection.....	3
3.2 Location .....	3
3.3 Set-Up.....	3
3.4 Ducting.....	4
3.5 Avoiding Secondary damage.....	4
3.6 Electrical Requirements.....	4
4. Operation Instructions.....	4
4.1 Connect and Start-Up Procedure .....	4
4.2 Cool Down .....	5
4.3 Shut Down and Disconnect Procedure .....	5
5. Control Panel .....	5
5.1 Main Disconnect.....	5
5.2 Standby Light.....	5
5.3 Phase Out.....	5
5.4 Selector Switch.....	5
5.5 Alarm (Light and Horn).....	5
5.6 Hour Meter .....	5
6. Maintenance .....	5
6.1 General Maintenance .....	5
6.2 Cabinet.....	5
6.3 Filter .....	5
6.4 Blower and Motor.....	6
6.5 Drive Motor.....	6
6.6 Rotor Drive Chain .....	6
6.7 Seals .....	6
6.8 Desiccant Media.....	6
7. Wiring Diagram .....	7
8. Trouble Shooting .....	10
9. Detailed Sequence of Events .....	11
10. Service Parts List .....	12
11. Warranty.....	13

Serial No. \_\_\_\_\_

Purchase Date \_\_\_\_\_

Dealer's Name \_\_\_\_\_

Read the operation and maintenance instructions carefully before using this unit. Proper adherence to these instructions is essential to obtain maximum benefit from your Phoenix 4800E.

**WARNING: \*\*You are responsible to secure all doors and accessories during transit.\*\***

# 1 Specifications

## Specifications for 4800E

**Part No.** 4034830 (with Frame)  
4034820 (without Frame)  
4034850 (with Frame Docking)  
4034840 (without Frame Docking)

**Power** 480 VAC, 3-Phase, 106 FLA

**Water Removal** 3032 pints/day @ AHAM

**Blower** 4800 CFM Process Air Flow  
2000 CFM Reactivation Air Flow

**Operating Range** -10°F to 140°F

**Filters** Process filter size: (2) 20" x 20" x 2"  
Reactivation filter size: (1) 20" x 20" x 2"

**Duct Options** Process Inlet: 20" Flex-Duct  
Process Outlet: 20" Flex-Duct/Lay Flat  
Reactivation Inlet: 20" Flex-Duct  
Reactivation Outlet: 10" Flex-Duct

**Warranty** 2 years:  
1st year Parts and Service  
2nd year Silica Gel Rotor

### Dimensions

Machine  
**Width** 48"  
**Height** 74"  
**Length** 120"  
**Weight** 1600 lb

### Accessories

4028365 Heavy Duty PVC/Polyester Duct 20" x 25'6" Pitch

4035579 Heavy Duty PVC/Polyester Duct 20" x 25'4" Pitch

**NOTE: Duct with 4' pitch is mandatory for the return duct if you are recirculating.**

4024440 Kestrel 3000 Multi-Function Air Meter

4027327 External Temperature control

4036662 External Dehumidistat

4029003 Power Cord Grip

Air Filter Replacement

4028635 20" x 20" x 2" Filter

# 2 Operation

The function of the dehumidifier is to remove moisture (in the vapor state) from an air stream. This is accomplished by exposing the air to an adsorbing media (desiccant) in

a sealed air stream (process). After the desiccant has adsorbed moisture, it is exposed to a second air stream at an elevated temperature (reactivation). This causes the moisture to be driven out of the desiccant preparing it for more moisture adsorption. This process is done on a continuous basis, providing a constant drying process. The two air streams (process and reactivation) are separated by seals, which contact the desiccant media. Figure 1 illustrates the relationship of the seals and airflow pattern. The dehumidifier is designed with the two air streams flowing in opposite directions (counter flow) thereby maximizing the energy efficiency of the equipment.

### Principle of Operation

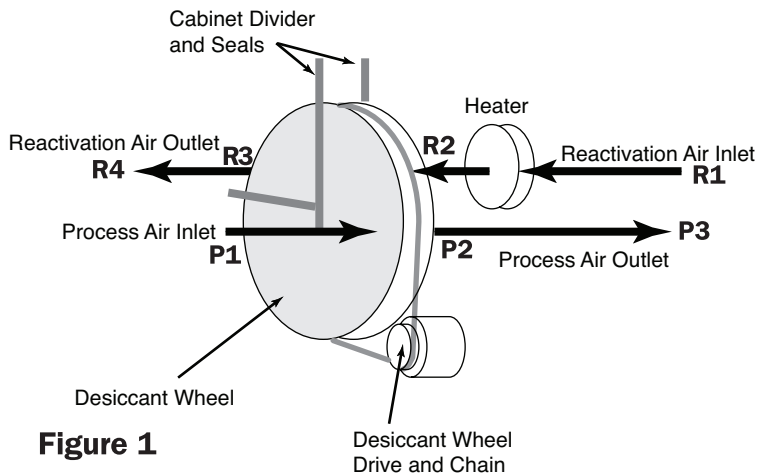

**Figure 1**

### 2.1 How the Phoenix 4800E Works

The Phoenix 4800E has two separate air streams that run through it – Process and Reactivation (Fig. 1).

#### Process Air Stream:

**P1** – 4800 CFM of air enters the machine (Process Air Inlet) and...

**P2** – ...water vapor from incoming air is deposited (adsorbed) on the desiccant wheel.

**P3** – 4800 CFM of dry air exits the machine (Process Air Outlet).

#### Reactivation Air Stream:

**R1** – 2000 CFM of air enters the machine (Reactivation Air Inlet) and...

**R2** – passes over the heater coils.

**R3** – Water vapor is picked up (desorbed) from the desiccant wheel by the hot air and...

**R4** – ... 2000 CFM of wet air exits the machine (Reactivation Air Outlet).

## 3 Installation

Proper installation is critical to the performance of the Phoenix 4800E. Follow the guidelines below to maximize service life and performance.

### 3.1 Inspection

Thoroughly inspect the machine to insure no damage has occurred during shipping or on the job site.

### 3.2 Location

**Note the following precautions when locating the Phoenix 4800E:**

The 4800E is designed to be used indoors or outdoors.

If the humid area is very large, dehumidification can be improved by adding an outlet duct to circulate process air to stagnant areas.

### 3.3 Set-Up

When conditions warrant the use of a desiccant dehumidifier, use one of the setups described below to achieve efficient drying, while avoiding secondary damage. Review Section 2.1 to understand the desiccant drying process. Always ensure that the Reactivation Outlet duct is vented to the outdoors to minimize the possibility of secondary damage.

#### Neutral Pressure Setup

Many drying applications require neutral pressure operation. In this setup, the Process Air Inlet pulls air from the affected area (drying chamber) and returns dried, processed air to the affected area via the Process Air Outlet.

The Reactivation Air Inlet and Outlet are both ducted to the outdoors (or left open if the unit is set up outside).

#### Positive Pressure Setup

For Positive Pressure operation, the Process Air Inlet pulls air from outside the drying chamber, while the Process Air Outlet is ducted into the chamber.

The Reactivation Air Inlet and Outlet are both ducted to the outdoors (or left open if the unit is set up outside).

### 3.4 Ducting

The duct requirements of the 4800E are much more critical than those of refrigerant-based dehumidifiers. **ALL SUPPLY AND RETURN AIR DUCTING FOR THE 4800E MUST BE AIR AND VAPOR TIGHT.** This is extremely important for proper performance. Ensure that reactivation discharge air does not enter the process or reactivation inlets.

Using excess duct length significantly reduces air flow volume through duct. This is true in any application. If the job at hand needs a short length of duct, cut a section to the appropriate length. If air flow is restricted by excess length, performance will suffer. The same can be said of excess bends in the ducting.

Two different duct sizes are used on the 4800E. All ducting materials are available from Therma-Stor LLC (see accessories list in Section 1).

#### Process inlet / Reactivation inlet: 18" flex duct.

To attach flex ducts to the process air intake, push the wire of the first few loops beyond the 2 holes in the duct collar. Push the metal rod through the duct and duct collar piercing the duct in two places. Tape or a hose clamp can be used to create an airtight seal. Alternatively, the duct wire can be pushed past the weld beads on the duct collar and the duct can be secured with hose clamps or ratcheting straps. If using only one inlet connection, the other can be left closed.

#### Process outlet: 18" flex or lay flat plastic duct.

To attach flex ducts to the process air outlet, push the wire of the first few loops beyond the 2 holes in the duct collar. Push the metal rod through the duct and duct collar piercing the duct in two places. Tape or a hose clamp can be used to create an airtight seal. Alternatively, the duct wire can be pushed past the weld beads on the duct collar and the duct can be secured with hose clamps or ratcheting straps.

When using 18" lay flat ducting, slip over the outlet collar and zip-tie or duct tape in place.

#### Reactivation outlet: 10" flex duct.

To attach flex duct to the reactivation air outlet, push the wire of the first couple of loops beyond the weld beads on an outlet collar. Secure with hose clamp.

### 3.5 Avoiding Secondary Damage

The Phoenix 4800E is a powerful tool capable of removing a great deal of water from most environments. Care must be taken to avoid secondary damage of over-drying and or unexpected condensation.

The Phoenix 4800E removes vapor water from the incoming process air stream and transfers it to the outgoing reactivation air stream. The reactivation exhaust air is hot and wet.

Take care to prevent the reactivation exhaust air stream from causing secondary damage due to condensation.

If the exhaust from reactivation air stream cools below its dew point, liquid water will condense inside the duct work creating puddles. If the reactivation exhaust air stream is not exhausted completely from the structure it can also cause

secondary water damage.

The Phoenix 4800E does not produce liquid water internal to the machine. There is no condensate pump and no drain hose.

The 4800E desiccant dehumidifier will continue to remove water from already dry, cold air. It is possible to over-dry objects and or structures.

Care must be taken to avoid secondary damage due to over-drying.

### 3.6 Electrical Requirements

A 480 volt, 3 phase power source is required to operate the Phoenix 4800E.

All local and state codes must be strictly adhered to and good electrical practices should be followed to achieve the best installation possible. The 4800E must be properly wired to an adequate power source. Serious damage to the motors and controls can occur if incorrect voltage is applied.

(See Electrical Schematic drawing in the back of this manual for internal wiring.)

## 4 Operating Instructions

Refer to the Operating Instructions label located next to the control panel of your 4800E.

### WARNING

User-supplied power cord, cord grip, and branch protection appropriate for the electrical load must be supplied. See device for FLA rating.

The Phoenix 4800E dehumidifier comes complete and ready for operation. All that is required is to provide the proper power source and duct connections (described above).

#### 4.1 Connect and Start-Up Procedure

- 1) Lockout Power Source.
- 2) Wire unit 480 Volt 3 Phase.
- 3) Verify Selector Switch is set to STANDBY.
- 4) Engage Power Source and turn Main Disconnect to ON.
- 5) Verify PHASE OUT light is off, if not, re-wire power source to correct phase order.
- 6) COOL DOWN light will come on for 5 minutes.
- 7) Set Selector Switch to RUN.
- 8) Set process damper to obtain a maximum of 1.5" water column pressure as read on pressure gauge.

## 4.2 Cool Down

- 1) Set Selector Switch to STANDBY.
- 2) COOL DOWN light will come on for 5 minutes.
- 3) When COOL DOWN light is off, Main Disconnect can be switched to OFF.

### **WARNING**

Failure to follow **COOL DOWN PROCEDURE** may result in damage to unit due to overheating. **ALWAYS** follow **COOL DOWN PROCEDURE** before shutting unit down.

## 4.3 Shut Down & Disconnect Procedure

- 1) Verify COOL DOWN light is not illuminated and Cool Down Procedure has been followed.
- 2) Turn Main Disconnect Switch to OFF.
- 3) Disengage Power Source.
- 4) Lock Out Power Source.
- 5) Disconnect Power Cable.

# 5 Control Panel

## 5.1 Main Disconnect

The main disconnect switches power from the source to the panel. Power must be disconnected at the source prior to accessing control panel. Access to the control panel with power applied is **ONLY** by qualified service personnel with the appropriate personal protective equipment

Power is present up to disconnect even in OFF position. Disconnect power at the source before opening panel.

## 5.2 Standby Light

The STANDBY indicator lamp illuminates to indicate that power is supplied to the control panel.

## 5.3 Phase Out

The PHASE OUT indicator lamp illuminates to indicate that the 3-phase power is not correctly wired into the power supply. Change the wiring at the power supply connection to correct the phase order.

## 5.4 Selector Switch

When the selector switch is moved to the "RUN" position, the 4800E starts dehumidifying. The machine will continue to dehumidify in all conditions until the power is turned off. No dehumidistat is provided to monitor process inlet air condition (see over-dry warning section 3.5). An external control (dehumidistat, thermostat or other contact) can be wired in place of the jumper across terminals 3040 and 3042. The external control must be designed to operate a 115 VAC circuit.

## 5.5 Alarm (Light and Horn)

The alarm indicator lamp illuminates (and horn sounds) to indicate that a fault condition exists. The fault conditions could be:

- Motor Overload (process or reactivation)
- Reactivation Temperature greater than 375° F
- No dehumidification (i.e. saturated wheel)
- Low reactivation airflow
- Stuck heater contactor

An external alarm can be wired to terminals 3080 (power) and X2 (neutral). This would supply 115 VAC during an alarm condition.

## 5.6 Hour Meter

The hour meter will run whenever the 4800E is operating. This hour meter measures the cumulative time of operation in one-tenth hour increments. This meter is often used to verify hours on a job or to schedule maintenance.

# 6 Maintenance

## 6.1 General Maintenance

A definitive time schedule should be established for inspecting all rotating parts and components. Inspection requirements depend on the frequency of operation, transport, and operating conditions. Periodically check the condition of the air filter, rotating parts, and fasteners to ensure they are secure and in proper working order. Periodically check airflow to make sure there are no obstructions to airflow in outlet or inlet ductwork.

Recommended minimum inspections:

- Upon installation
- After 1 week of operation.
- Annually thereafter or upon loss of performance.

## 6.2 Cabinet

### **CAUTION**

*Disconnect power before removing access panels.*

Remove panel fasteners and panels from unit to access internal components. The condition of the cabinet gaskets should be observed during inspection and servicing to insure a good seal. Any leaks must be sealed and panels securely fastened for proper dehumidifier operation.

## 6.3 Filter

The maintenance interval for the filter depends directly on the cleanliness of the air entering the dehumidifier. It is suggested that a program be established to assure that the filters are replaced or cleaned prior to becoming clogged to the point they create a system problem.

Three aluminum (20"x20"x2") air filters must be checked regularly. Two filters are located near the process air inlet. The other one is located near the reactivation air inlet.

Wash the filters with fresh water. Clean the filter from the downstream side, forcing debris toward the filter inlet. Dry the filters completely before installing them in unit. Replacement filters can be ordered from the factory or purchased locally if available.

**DO NOT** operate the unit without the filters or with less effective filters as the desiccant wheel inside the unit will become clogged and require disassembly to clean.

#### 6.4 Blower and Motor

Blower and motor bearings are permanently lubricated and do not require maintenance. Blower wheel - inspect wheel blades for accumulation of dust and dirt. Clean thoroughly with compressed air and or vacuum. The wheel should not strike the housing or the inlet ring. Make sure wheel is rotating in the proper direction.

#### 6.5 Drive Motor

The media drive motor is permanently lubricated and requires no maintenance.

#### 6.6 Rotor Drive Chain

A spring loaded tensioner keeps the chain sufficiently tensioned. Check the chain for signs of excessive wear. Replace as necessary. If additional tension is required, simply tighten the nuts on the tension springs as required.

#### 6.7 Seals

High temperature seals separate the process and reactivation compartments. Normally, the seals will not require service or replacement. However, should damage occur, or if poor performance as the result of an air leak is suspected, the following inspection must be performed to determine whether the seals should be replaced:

##### Inspection:

- 1) Turn the unit off and remove the access covers.
- 2) Visually inspect for gaps between the desiccant media and the seals.
- 3) If significant gaps, wear, or damage are observed, the seal needs to be replaced.

#### 6.8 Desiccant Media

The silica gel desiccant media supplied with the dehumidifier will last indefinitely under ideal conditions. Due to the nature of desiccants they make very good filters. The life of the desiccant is directly related to the airborne contaminants passed through it. Atmospheric contaminants, exposure to acidic gases/or air streams, and contact with petroleum based airborne particles can reduce the efficiency of the desiccant media. The preferred method of cleaning is to blow dust out with compressed air. Proper filtration

and preventing contact with chemicals will greatly improve the life of the desiccant. Inspect the face of the media to see that no surface damage has occurred. If damage is noticed, please contact Therma-Stor at 1-800-533-7533 for assistance. The rotor should turn smoothly upon the shaft, if not check the support bearings.

### CAUTION

*Servicing the Phoenix 4800E with its high voltage circuitry presents a health hazard which could result in death, serious bodily injury, and/or property damage. Only qualified service people should service this unit.*

### CAUTION

***ELECTRICAL SHOCK HAZARD:** Electrical power must be present to perform some tests; these tests should be performed only by a qualified service person.*

# 7 Panel Layout/Wiring Diagram

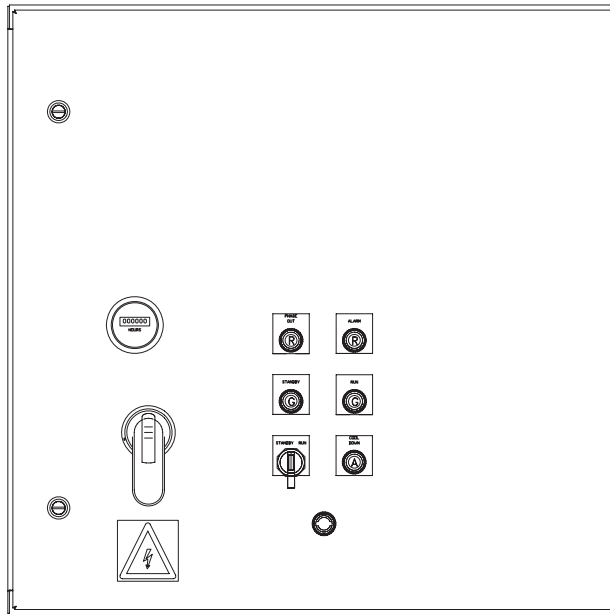

ENLARGED OPERATORS

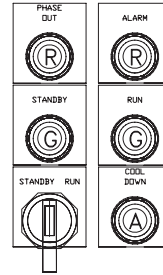

AFFIXED TO MAIN SUBPANEL

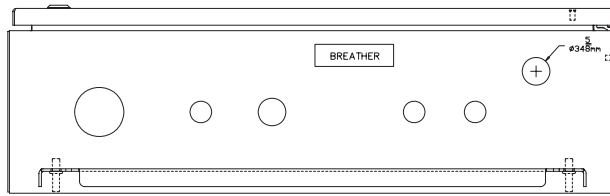

SUB-PANEL

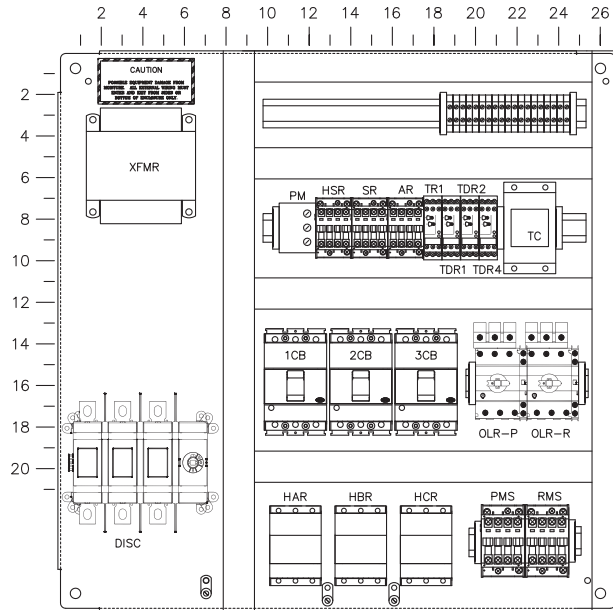

ENLARGED TERMINALS

1
X2
X2
X2
3010
3040
3042
3044
3044
3080
3080
3180
3274
3276
3470
3470
3470
GND
GND

# 7 Panel Layout/Wiring Diagram

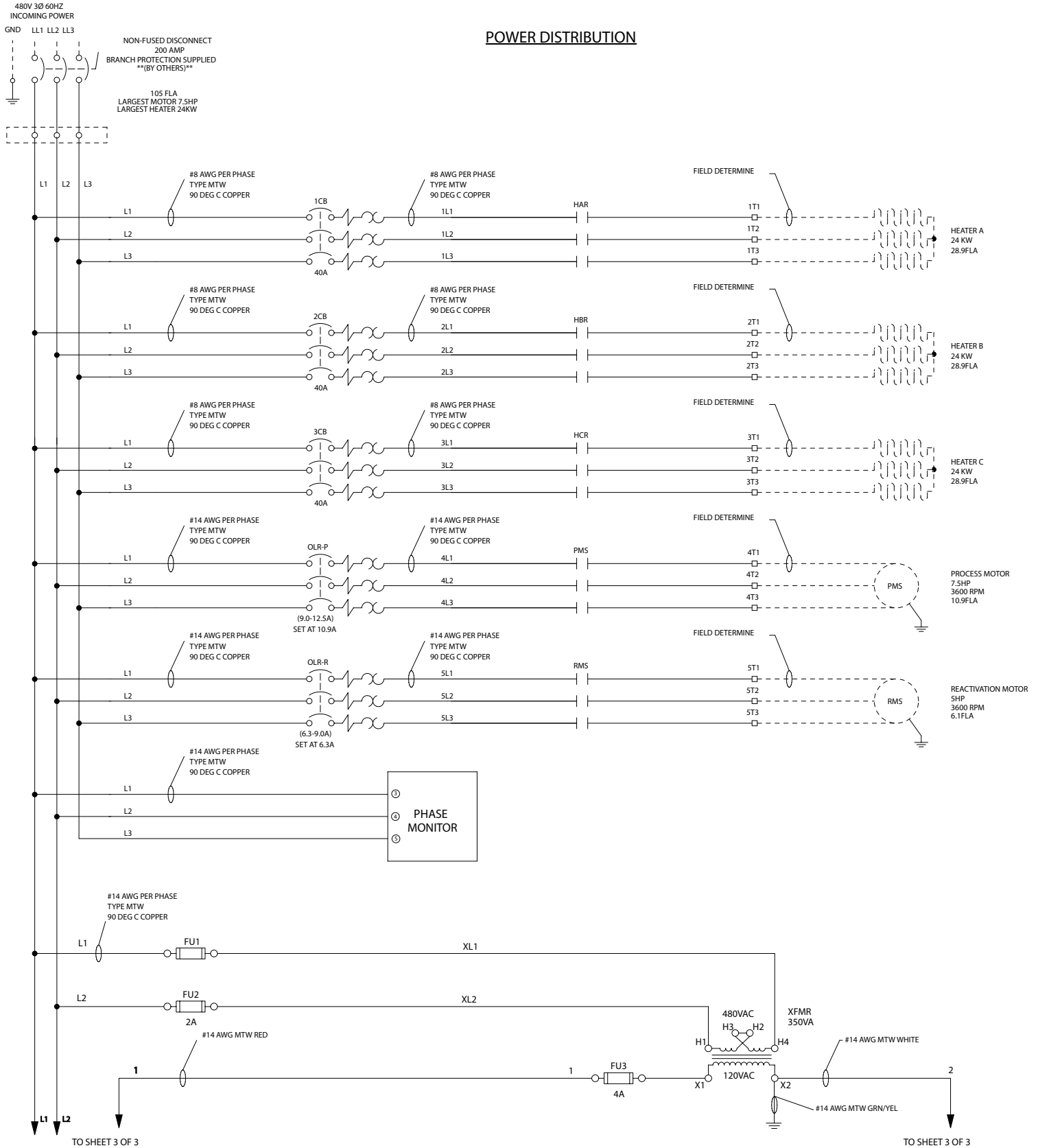





## 8 Trouble Shooting

<b>Trouble</b>	<b>Probable Fault</b>	<b>Probable Cause</b>	<b>Corrective Action</b>
<b>Unit Stopped (fan off, no heater)</b>	<b>Power/Control Failure</b>	<ol style="list-style-type: none"> <li>1. Main power off</li> <li>2. Main disconnect open</li> <li>3. Selector switch open</li> <li>4. Dehumidistat</li> </ol>	<p>Check main power and cable</p> <p>Close or replace disconnect</p> <p>Close or replace switch</p> <p>Repair or replace</p>
<b>Fan off (Rotor turns)</b>	<b>Power/Mechanical Failure</b>	<ol style="list-style-type: none"> <li>1. Motor circuit breaker or overload tripped</li> <li>2. Contactor failure</li> <li>3. Motor winding failure</li> <li>4. Fan motor failure</li> </ol>	<p>Reset circuit breaker or overload</p> <p>Repair or replace</p> <p>Repair or replace</p> <p>Repair or replace</p>
<b>Unit running but humidity rises</b>	<b>Excessive infiltration of humid air into the controlled area</b>	<ol style="list-style-type: none"> <li>1. Excessive unconditioned make-up air</li> <li>2. Leaking ducts or air handling equipment outside controlled area</li> <li>3. Access opening to area not sealed</li> <li>4. Area not vapor tight</li> </ol>	<p>Reduce make-up air</p> <p>Seal leaks</p> <p>Close and seal</p> <p>Seal with paint or vapor barrier</p>
	<b>Faulty humidity controls</b>	<ol style="list-style-type: none"> <li>1. Dehumidistat needs adjustment</li> <li>2. Improper settings</li> <li>3. Defective</li> </ol>	<p>Re-adjust</p> <p>Re-adjust</p> <p>Replace</p>
	<b>Inadequate air flow</b>	<ol style="list-style-type: none"> <li>1. Dirty filter</li> <li>2. Obstruction at inlet, outlet or ducting</li> <li>3. Clogged desiccant media (high pressure differential across media)</li> </ol>	<p>Clean or replace</p> <p>Remove obstruction</p> <p>Remove and replace media rotor</p>
	<b>Inadequate or no reactivation heat</b>	<ol style="list-style-type: none"> <li>1. Element failure</li> <li>2. Low / no voltage</li> <li>3. Control elements failure</li> </ol>	<p>Check elements – repair or replace</p> <p>Correct power supply / breakers</p> <p>Control set point / repair or replace</p>
	<b>Air seals and gaskets</b>	<ol style="list-style-type: none"> <li>1. Air leaking into dehumidifier</li> <li>2. Air bypassing media or leaking seals</li> </ol>	<p>Replace access door gaskets</p> <p>Check media position, replace seals</p>
	<b>Ineffective desiccant media</b>	<ol style="list-style-type: none"> <li>1. Chain</li> <li>2. Motor/gear box</li> <li>3. Damaged desiccant rotor</li> <li>4. Contaminated or damaged desiccant</li> </ol>	<p>Repair or replace</p> <p>Repair or replace</p> <p>Repair or replace</p> <p>Replace desiccant rotor</p>

# 9 Detailed Sequence of Events

## - Control Operation

- 1) Turning on Main Disconnect at dehumidifier provides 480 VAC, 3 phase power to the control panel. Power is distributed to breakers for blower motors, heaters and the control transformer. The control transformer supplies 115 VAC for control system and desiccant wheel motor.
  - a) PHASE OUT lamp, if illuminated, indicates the power supply is not connected correctly. Rewire power supply as needed.
  - b) STANDBY lamp illuminates.
  - c) Rotor motor terminals, 3470 and X2, energize providing the desiccant motor with 115 VAC power. Desiccant wheel begins to rotate.
  - d) Reactivation motor starter RMS contacts close, starting the reactivation blower.
  - e) COOL DOWN light illuminates, indicating the timed heater cool down cycle has started.
  - f) Time relay TR1 starts the 5 minute heater cool down cycle. Contacts are normally closed, timed open (NCTO). Following the delay...
    - l) TR1 relay energizes, opening contacts for the COOL DOWN light and reactivation blower motor starter (RMS). Rotor motor terminals 3470 and X2 de-energize.

**Note: The cool down cycle can be interrupted if the RUN position is selected and no alarm conditions are present.**

- 2) Selecting the RUN position (selector switch) ...
  - a) Provides power to the temperature control TC.
  - b) Start relay SR energizes, if no alarm conditions are present (AR relay de-energized)
    - I) Time relay TR1 and COOL DOWN light de-energize. Run indicator illuminates. Reactivation blower motor starter is energized. Pressure switch PS1 is activated when reactivation airflow reaches minimum level.
    - II) TDR2 starts a 20 second delay followed by energizing Process motor start (PMS), hour meter, and TDR4 40sec timer. If pressure switch PS1 was not activated in previous step due to lack of airflow, Alarm relay is energized and unit is not allowed to run.
    - III) Heater "A" Relay HAR energizes, if auxiliary contacts of the reactivation motor overload (RMS) are closed and the temperature control is calling for heat.
    - IV) Upon TDR4 reaching 40seconds, remaining heat contactors HBR and HCR are energized
- 3) If temperature in reactivation heater plenum exceeds 375° F, the temperature control TC will close its

auxiliary contact, energizing the latching alarm relay AR.

- a) ALARM lamp illuminates.
- b) Alarm horn sounds.
- c) Terminals 3080 and X2 energize. These terminals can be utilized for an external alarm (1 amp maximum).
- d) Time relay TR1 starts the 5 minute heater cool down cycle. Following the delay...
  - l) TR1 relay energizes, opening contacts for the COOL DOWN light and reactivation blower motor starter (RMS). Rotor motor terminals 3470 and X2 de-energize.

Reset alarm by turning the selector switch to STANDBY.

Probable causes for a high temperature fault are reduced air flow, dirty filter, incorrect reactivation blower rotation, or blower failure.

- 4) On a fault from an overload relay (OLR-P or OLR-R), the latching alarm relay (AR) energizes. The effect is listed in lines 3a through 3d.

Turn the selector switch to STANDBY, allowing the cool down cycle to complete before turning OFF the main disconnect. Follow Lock Out – Tag Out procedure to de-energize the power cord supplying the 4800. Reset the overload relay located in the control cabinet. Close and secure cabinet door. Energize unit following proper Lock Out – Tag Out procedure.

Probable causes for a fault from an overload relay are insufficient restriction of airflow (overloading motor by allowing excessive airflow) or blower/motor failure.

- 5) On a fault from the internal process dehumidistat that persists for 20 minutes, the latching alarm relay (AR) energizes. The effect is listed in lines 3a through 3d. TDR1 provides a 10 minute delay for the removal of residual humidity desiccant during startup.
 

Reset alarm by turning the selector switch to STANDBY.

Probable causes for a fault from the internal dehumidistat are heater failure or desiccant failure.
- 6) On a fault from a stuck heater contactor, the Alarm Relay will energize and the reactivation blower will remain on continuously. The Rotor will continue to turn, but the process blower will NOT come on. Shut off power with the main disconnect and replace the inoperable contactor to clear the error.

**No dehumidistat is provided to monitor process inlet air condition (see over-dry warning section 3.5). An external control (dehumidistat, thermostat or other dry contact) can be wired in place of the jumper across terminals 1 and 3082. The external control must be designed to operate a 115 VAC circuit. Contact closure will start dehumidification. A control wired across terminals 1 and 3082 will be in series with the selector switch. Turn the selector switch to RUN to operate the dehumidifier from an external control.**

## 10 Service Parts

Item	Part No.	Qty.	Description
1	4027228	1	Blower, Reactivation, 460V, 5HP
2	4027229	1	Blower, Process, 460V, 7.5HP
3	4028630	1	Probe, Thermocouple, Type J, 12"
4	4028633	3	Heating Element, 24KW
5	4036662	1	Dehumidistat
6	4028771	1	Temperature Controller with Control Output Board, Relay SPST
7	4032306	1	Control Box
8	4030198	2	Fusa 2A
9	4030199	1	Fuse 4A



**Therma-Stor** LLC

4201 LIEN RD. • MADISON, WI 53704



**PHOENIX**

## Phoenix 4800 Desiccant Dehumidifier

### LIMITED WARRANTY

**Warrantor:**

Therma-Stor LLC

4201 Lien Rd

Madison, WI 53704

Telephone: 1-800-533-7533

**Who Is Covered:** This warranty extends only to the original end-user of the 4800 and may not be assigned or transferred.

**First Year Warranty:** Therma-Stor Products warrants that, for one (1) year the 4800 will operate free from any defects in materials and workmanship, or Therma-Stor Products will, at its option, repair or replace the defective part(s), free of any charge.

**End-User Responsibilities:** Warranty service must be performed by a Servicer authorized by Therma-Stor Products. If the end-user is unable to locate or obtain warranty service from an authorized Servicer, he should call Therma-Stor Products at the above number and ask for the Therma-Stor Products Service Department, which will then arrange for covered warranty service. Warranty service will be performed during normal working hours.

The end-user must present proof of purchase (lease) upon request, by use of the warranty card or other reasonable and reliable means. The end-user is responsible for normal care. This warranty does not cover any defect, malfunction, etc. resulting from misuse, abuse, lack of normal care, corrosion, freezing, tampering, modification, unauthorized or improper repair or installation, accident, acts of nature or any other cause beyond Therma-Stor Products' reasonable control.

**Limitations and Exclusions:** If any 4800 part is repaired or replaced, the new part shall be warranted for only the remainder of the original warranty period applicable thereto (but all warranty periods will be extended by the period of time, if any, that the 4800 is out of service while awaiting covered warranty service).

UPON THE EXPIRATION OF THE WRITTEN WARRANTY APPLICABLE TO THE 4800 OR ANY PART THEREOF, ALL OTHER WARRANTIES IMPLIED BY LAW, INCLUDING MERCHANTABILITY AND FITNESS FOR A PARTICULAR PURPOSE, SHALL ALSO EXPIRE. ALL WARRANTIES MADE BY THERMA-STOR PRODUCTS ARE SET FORTH HEREIN, AND NO CLAIM MAY BE MADE AGAINST THERMA-STOR PRODUCTS BASED ON ANY ORAL WARRANTY. IN NO EVENT SHALL THERMA-STOR PRODUCTS, IN CONNECTION WITH THE SALE, INSTALLATION, USE, REPAIR OR REPLACEMENT OF ANY 4800 OR PART THEREOF BE LIABLE UNDER ANY LEGAL THEORY FOR ANY SPECIAL, INDIRECT OR CONSEQUENTIAL DAMAGES INCLUDING WITHOUT LIMITATION WATER DAMAGE (THE END-USER SHOULD TAKE PRECAUTIONS AGAINST SAME), LOST PROFITS, DELAY, OR LOSS OF USE OR DAMAGE TO ANY REAL OR PERSONAL PROPERTY.

Some states do not allow limitations on how long an implied warranty lasts, and some do not allow the exclusion or limitation of incidental or consequential damages, so one or both of these limitations may not apply to you.

**Legal Rights:** This warranty gives you specific legal rights, and you may also have other rights which vary from state to state.